

# 5

## 分体式电缆接头系统 *Splittable cable gland systems*

5



UNI FLANSCH –  
塑料和锌压铸材质的分体式法兰  
系统

*UNI Flange® – splittable flange  
systems made of plastic and zinc  
die casting*

5



1

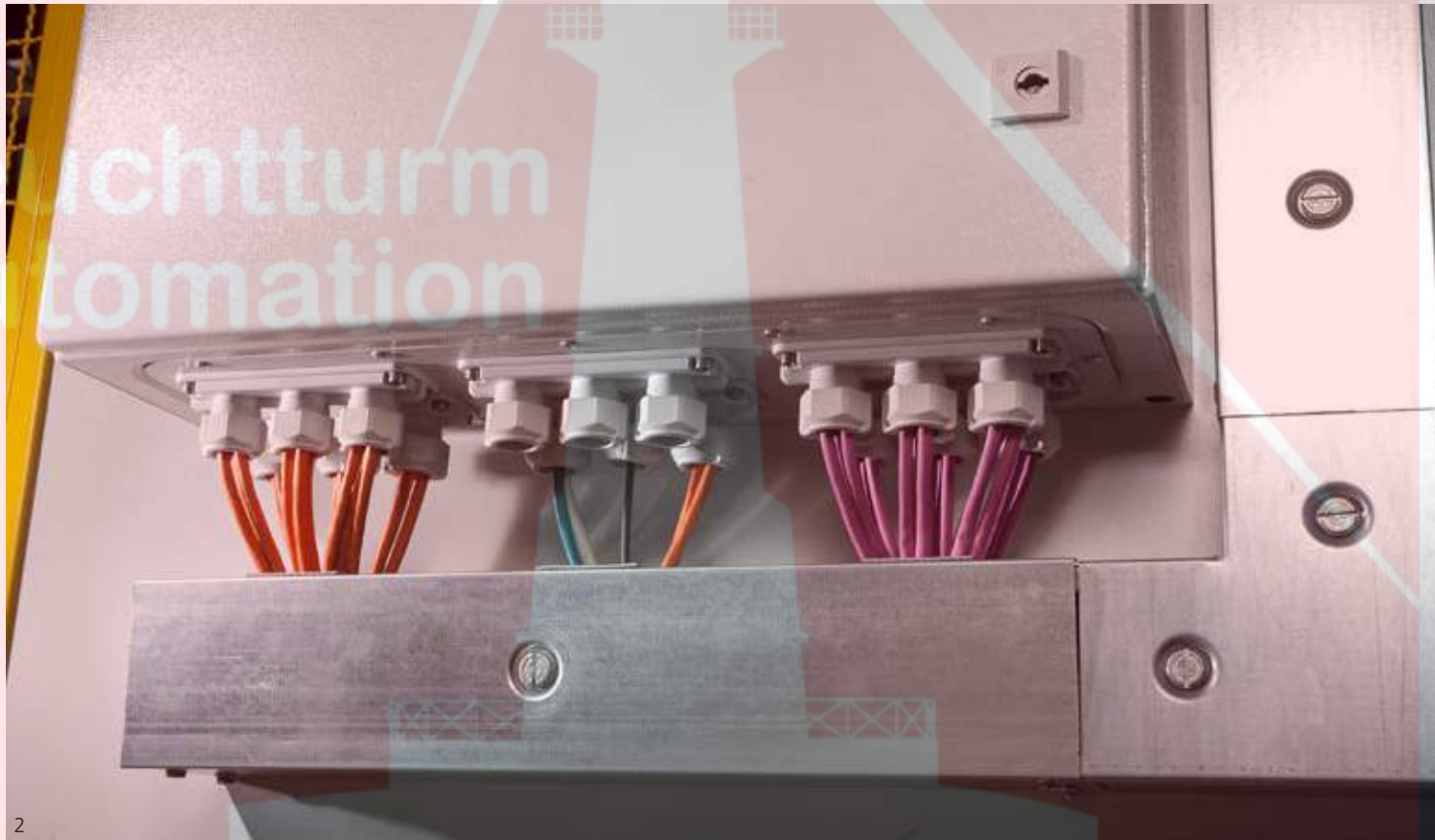

2

图 1 – UNI FLANSCH HD  
Fig. 1 – UNI Flange® HD

图 2 – UNI FLANSCH 使用中  
Fig. 2 – UNI Flange® in use

### 分体式电缆接入装置

如何将预制电缆穿过用于 24 极连接器的标准孔缝并牢固地安装 PFLITSCH 为此开发了解决方案：分体式 UNI FLANSCH。UNI FLANSCH 是唯一的基于电缆接头密封原理的分体式法兰解决方案。该法兰解决方案将 UNI Dicht® 系统的特性与分体式框架板和分体式压力螺钉的优点结合在一起。UNI FLANSCH 有塑料和金属材质可供选择。金属版适宜在严苛的工业环境中使用而设计 (UNI FLANSCH HD – Heavy Duty)。

### 令人信服的特性

PA 或锌压铸材质的分体式框架板集成有三个接头本体，插入其中使用的 UNI Dicht® 系统的内塞有超过 100 种。通过本体和内塞的凹槽，可以避免在拧紧压力螺钉时，内塞和电缆跟着一起转动：UNI Dicht® 系统的另一优点。

采用 TPE-V 材质的内塞能安全通过截面 2.0 mm 至 20.5 mm 的电缆进出壳体。在此过程中，软性挤压可避免对电缆护套造成严重损伤的电缆收缩挤压造成的变形。该紧固原理还符合 EN 62444 标准 A 级的抗拉力标准。内塞以及框架板周边的紧固件可阻止粉尘和溅水渗透进去，因此达到了防护等级 IP 66 和 Type 4X。所有这些优点使这两个法兰版本适用于 -20 °C 至 +80 °C 的使用温度。框架板有穿孔。塑料版本还有螺纹内塞。由此达到了符合 2 级保护 (DIN EN 61140, VDE 0140-1) 的全接触保护。PA 框架板和分体式 PA 压力螺钉有灰色和黑色可供选择。

### 操作简单

仅需要较少部件就可以可靠地穿过并紧固多根电缆。这确保了安装的快速简单：两个框架板包覆在电缆周围，互相扣紧并固定在切口处。然后将预制电缆插入有开缝的内塞并将其推到接头本体内。现在只需要用压力螺钉包围住电缆，互相卡死并拧紧螺纹接头即可一完成。

### The splittable cable entry

What is the best method of routing a pre-assembled cable through standard hole cut-outs for 24-pole connectors and sealing them securely? PFLITSCH has developed a solution for this: the splittable UNI Flange®. The UNI Flange® is the only splittable flange solution that is based on the sealing principle of a cable gland. With this flange solution, the properties of the UNI Dicht® system are combined with the advantages offered by a splittable frame plate and splittable pressure screw. The UNI Flange® is available made of plastic and zinc die casting. The metal version is for applications in industrial environments (UNI Flange® HD – Heavy Duty).

### Impressive characteristics

Three double nipples are integrated into the PA plastic or zinc die casting splittable frame plate – into which over 100 different sealing inserts from the UNI Dicht® system can be fitted. The grooves in the double nipple and on the inserts prevent the sealing insert and the cable from turning as the pressure screw is tightened. This is a further positive characteristic of the UNI Dicht® system.

The sealing inserts, manufactured of TPE-V, can be used to securely route cables of between 2.0 mm and 20.5 mm cross-section into or out of an enclosure. The soft pinching action of the gland does not constrict the cable; otherwise the cable sheathing would suffer serious damage. This sealing principle offers the additional benefit of high class A strain relief in accordance with EN 62444. The sealing inserts and the circumferential seal on the frame plate prevent the ingress of dust and hose water and therefore achieve protection class IP 66 and Type 4 or Type 4X. The Flange variants offer all of these benefits at service temperatures of between -20 °C and +80 °C. The frame plates are equipped with through holes. The plastic version is also available with threaded inserts. Thereby full contact protection to class 2 (DIN EN 61140, VDE 0140-1) can be achieved. The frame plates made of PA and the splittable PA pressure screws are available in grey and black.

### Simple to use

Very few individual parts are necessary in order to securely route a large number of cables. This guarantees fast and easy assembly: Place both halves of the frame around the cables, connect them together and fasten the frame at the cut-out. Then simply insert the preassembled cables into the slotted sealing inserts and push these into the double nipple. The final step is to place the pressure screws around the cable, snap them together and tighten at the threaded nipple – and you're finished.



图 1 – UNI FLANSCH® 带通孔  
Fig. 1 – UNI Flange® with through holes

图 2 – UNI FLANSCH® 带螺纹嵌件  
Fig. 2 – UNI Flange® with threaded inserts

图 3 – 使用撑开钳可以更容易地将电缆放到有开缝的多孔内塞中。  
Fig. 3 – Placing the cable into the slit multiple sealing insert is made easier with the expanding pliers.

UNI Flange® — 带塑料通孔的整体框架

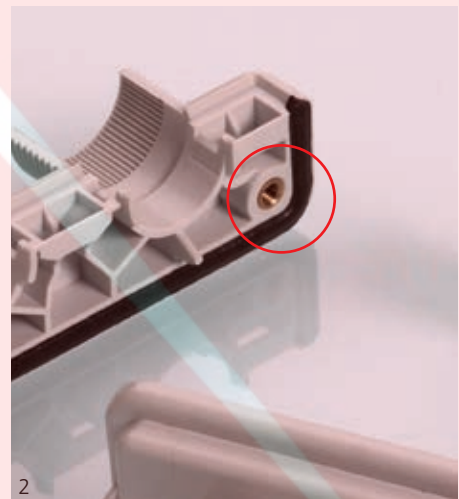
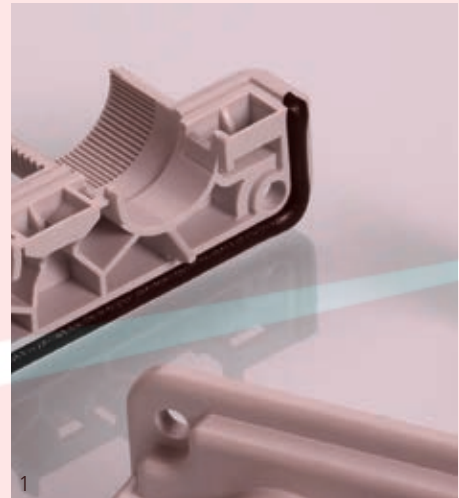
UNI Flange® – Complete frame with through holes plastic



图 1  
Fig. 1



图 2  
Fig. 2

包装单元包括:  
10 个带通孔的框架半体板  
30 个压力螺栓半体件  
20 个密封垫片  
防护等级 IP 66, 类型 4X

Packaging unit consisting of:  
10 frame plates with through holes, 30 pressure screw halves,  
20 washers  
Type of protection IP 66, Type 4X

**i** 24 极截面尺寸 (单位: mm) : 112 x 36  
Dimensions of the 24-pole cut-out (mm): 112 x 36

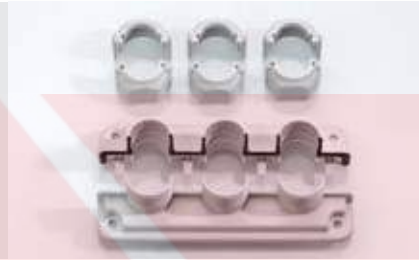
| 螺纹接头外壳材质<br>Material gland body | 颜色<br>Colour | 订购编号<br>Art. no. supplement | 温度范围最小值/最大值<br>Temperature range min./max. |
|---------------------------------|--------------|-----------------------------|--|
| PA 66-6                         | 灰色<br>grey   |                             | -20 °C / +80 °C                            |
| PA 66-6                         | 纯黑色<br>black | n                           | -20 °C / +80 °C                            |



图 3  
Fig. 3

| 料号<br>Art. no. | 宽度 1<br>Width 1 | 高度 1<br>Height 1 | 宽度 2<br>Width 2 | 高度 2<br>Height 2 | 直径<br>diameter | 扳手开口宽度<br>Spanner width |
|----------------|-----------------|------------------|-----------------|------------------|----------------|-------------------------|
| grey =         | B1              | H1               | B2              | H2               | Ø d            | SW x E                  |
| black = n      | mm              | mm               | mm              | mm               | mm             | mm                      |
| CUFLD3 954u    | 149.6           | 51.6             | 130             | 32               | 5.5            | 35x38.6                 |

**i** 用于安装的螺栓不在发货范围内。我们建议使用 M5 内六角圆柱头螺栓 (Inbus)。  
Screws for the installation are not included with the articles. We recommend M5 socket-head screws with a hexagonal socket (allen).

**i** UL 认证仅针对结合使用 TPE-V 材质的内塞  
UL certification only in combination with sealing inserts made of TPE-V

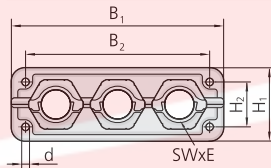
**i** M25 相应的带开缝内塞参见页码起自 96  
Corresponding slit sealing inserts in size M25 from page 96

UNI Flange® – 带塑料螺纹嵌件的整体框架

UNI Flange® – Complete frame with threaded inserts plastic



图 1  
Fig. 1



图 2  
Fig. 2

包装单元包括:  
10 个带螺纹嵌件的框架半体板  
30 个压力螺栓半体件  
防护等级 IP 66, 类型 4X

Packaging unit consisting of:  
10 frame plates with threaded inserts  
30 pressure screw halves  
Type of protection IP 66, Type 4X

**i** 24 极截面尺寸 (单位: mm) : 112 x 36  
Dimensions of the 24-pole cut-out (mm): 112 x 36

| 螺纹接头外壳材质<br>Material gland body | 颜色<br>Colour | 订购编号<br>Art. no. supplement | 温度范围最小值/最大值<br>Temperature range min./max. |
|---------------------------------|--------------|-----------------------------|--|
| PA 66-6                         | 灰色<br>grey   |                             | -20 °C / +80 °C                            |
| PA 66-6                         | 纯黑色<br>black | n                           | -20 °C / +80 °C                            |



图 3  
Fig. 3

| 料号<br>Art. no. | 宽度 1<br>Width 1 | 高度 1<br>Height 1 | 宽度 2<br>Width 2 | 高度 2<br>Height 2 | 扳手开口宽度<br>Spanner width |
|----------------|-----------------|------------------|-----------------|------------------|-------------------------|
| grey =         | B1              | H1               | B2              | H2               | SW x E                  |
| black = n      | mm              | mm               | mm              | mm               | mm                      |
| CUFLG3 954u    | 149.6           | 51.6             | 130             | 32               | 35x38.6                 |

**i** 用于安装的螺栓不在发货范围内。我们建议使用 M4 内六角圆柱头螺栓 (Inbus)。  
Screws for the installation are not included with the articles. We recommend M4 socket-head screws with a hexagonal socket (allen).

**i** UL 认证仅针对结合使用 TPE-V 材质的内塞  
UL certification only in combination with sealing inserts made of TPE-V

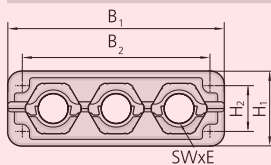
**i** M25 相应的带开缝内塞参见页码起自 96  
Corresponding slit sealing inserts in size M25 from page 96

UNI Flange® HD — 金属制整体框架

UNI Flange® HD – Complete frame metal



图 1  
Fig. 1



图 2  
Fig. 2

包装单元包括:  
10 个带通孔的框架半体板  
30 个压力螺栓半体件  
20 个密封垫片  
防护等级 IP 66, 类型 4

Packaging unit consisting of:  
10 frame plates with through holes, 30 pressure screw halves,  
20 washers  
Type of protection IP 66, Type 4

**i** 24 极截面尺寸 (单位: mm) : 112 x 36  
Dimensions of the 24-pole cut-out (mm): 112 x 36

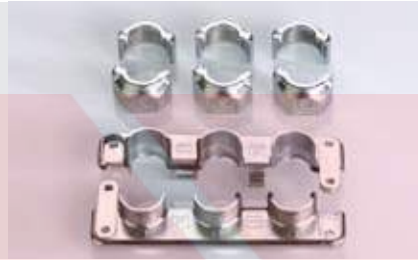
螺纹接头外壳材质  
Material gland body  
锌压铸件  
Zinc die casting

规格/颜色  
Version/colour  
镀锌  
zinc plated

温度范围最小值/最大值  
Temperature range min./max.  
-20 °C / +80 °C



图 3  
Fig. 3

| 料号<br>Art. no. | 宽度 1<br>Width 1<br>B1<br>mm | 高度 1<br>Height 1<br>H1<br>mm | 宽度 2<br>Width 2<br>B2<br>mm | 高度 2<br>Height 2<br>H2<br>mm | 直径<br>diameter<br>Ø d<br>mm | 扳手开口宽度<br>Spanner width<br>SW x E<br>mm |
|----------------|-----------------------------|------------------------------|-----------------------------|------------------------------|-----------------------------|---|
| CUFLD3 954Zn   | 149                         | 50                           | 130                         | 32                           | 5.5                         | 36x40                                   |

45100 | TT09810

**i** 用于安装的螺栓不在发货范围内。我们建议使用 M5 内六角圆柱头螺栓 (Inbus)。  
Screws for the installation are not included with the articles. We recommend M5 socket-head screws with a hexagonal socket (allen).

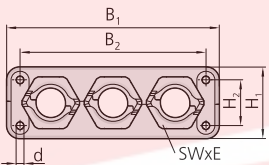
**i** UL 认证仅针对结合使用 TPE-V 材质的内塞  
UL certification only in combination with sealing inserts made of TPE-V

**i** UNI Flange® HD/UNI Split Gland® HD: 作为标准内塞仅使用 T80s 材质的带开缝内塞 (参见页码 99)。  
UNI Flange® HD/UNI Split Gland® HD: As sealing insert standard only use the slit sealing inserts made of T80s (see page 99).

**i** M25 相应的带开缝内塞参见页码起自 96  
Corresponding slit sealing inserts in size M25 from page 96

Leuchtturm  
Automation

UNI Split Gland® –  
分体式电缆接头

UNI Split Gland® –  
splittable cable gland

5



Leuchtturm  
Automation



图 1 – UNI Split Gland® 和 UNI Split Gland® HD, 规格为 M25  
Fig. 1 – UNI Split Gland® and UNI Split Gland® HD in size M25

图 2 – 用聚碳酸酯制成的分体式电缆接头 UNI Split Gland®  
Fig. 2 – Splittable cable glands UNI Split Gland® made of polycarbonat

### 部件少 — 供销大

PFLITSCH 推出塑料制和金属制完全分体式电缆接头 UNI Split Gland<sup>®</sup>，丰富了其分体式电缆接入装置的产品目录。接头本体和压力螺钉均由两部分构成，内塞侧面开缝，从而可以接入预制电缆。UNI Split Gland<sup>®</sup> 的主要特点：凭借分体式接头本体，整个钻孔直径都可以用于穿过已预装的连接器。UNI Split Gland<sup>®</sup> 基于 UNI Dicht<sup>®</sup> 原理并保证了电缆的可靠密封，不会造成不可修复的收缩挤压而导致的变形问题。相对应的 UNI Dicht<sup>®</sup> 目录中的 TPE-V 内塞 — 从闭合到多孔内塞，插入到分体式电缆接头中，实现较大的紧固范围。

### 虽然是分体式但仍可达到 IP 67

凭借内塞的软性大范围挤压和分体面上的密封件以及接口螺纹处的密封件，从而达到了 IP 67（根据 EN 60529）和 Type 4X。聚碳酸酯或锌压铸材质的 UNI Split Gland<sup>®</sup> 达到了 EN 62444 规定的抗拉力标准和 -20 °C 至 +80 °C 的使用温度范围。

### 需要替换 — 没问题

电缆接头的分体式设计不仅可以安装预制电缆，而且在需要加装电缆时也具有优势 — 无需拆卸预制电缆和中断生产。

### 在传统基础上的延续发展

由于部件少，UNI Split Gland<sup>®</sup> 的安装迅速而简单：将其或者电缆插入到内塞中 — PFLITSCH 在其目录中有一种针对此用途的实用撑开钳，将接头本体的两个部分包覆在已装内塞的电缆上，插入到卡紧位置并互相卡死。现在接头本体被安装在壳体内，内塞被推入其中。然后压力螺钉的两个部分包覆在装置周围，互相卡死并拧在螺栓本体上。如果需要拆卸 UNI Split Gland<sup>®</sup> 格兰头，可以用螺丝刀将接头的两个部分轻松地拧开。

### Minimum parts for maximum efficiency

PFLITSCH extends its range of splittable cable entries with the fully splittable UNI Split Gland<sup>®</sup> plastic and metal cable gland. The cable gland body and the pressure screw consist of two halves. The sealing inserts are slit at the side and thus allow preassembled cables to be placed in them. The special point about the UNI Split Gland<sup>®</sup>: the splittability of the cable gland body allows the whole of the hole diameter to be used for feeding through prefitted plugs. The UNI Split Gland<sup>®</sup> is based on the UNI Dicht<sup>®</sup> principle and therefore ensures the cable is dependably sealed without being irreparably cut into or severely indented. The appropriate TPE-V sealing inserts from the UNI Dicht<sup>®</sup> range – from the solid to the multiple-cable sealing insert – can be used with the split cable gland and realise a large sealing range.

### IP 67 – in spite of being splittable

The soft-squashing action exerted by the sealing insert over a large area of the cable sheath, the seal in the plane of the split and a further seal at the connection thread ensure that the gland achieves IP 67 protection (in accordance with EN 60529) and Type 4X. The UNI Split Gland<sup>®</sup> made from polycarbonate or zinc die casting also excels with strain relief in accordance with EN 62444 and an operating temperature range of -20 °C to +80 °C.

### Replacement needed – no problem

The cable gland can be split, which not only allows preassembled cables to be installed, it also has the advantage of allowing further cables to be installed later if necessary – without the need to dismantle preassembled cables or interrupt production.

### Conventional developments

Installing the UNI Split Gland<sup>®</sup> is quick and easy thanks to its few components: place the cable into the sealing insert – PFLITSCH has a practical set of spreading pliers available to help with this – fit the two halves of the cable gland body around the cable already in the sealing insert, bring the two halves together ready to engage and finally engage them. The cable gland body is now installed in the housing – either screwed into the thread or fastened with a splittable counter nut from the inside – and the sealing insert pushed into it. Then the two halves of the pressure screw are placed around the cable, engage with one another and screwed on to the cable gland body. If the UNI Split Gland<sup>®</sup> is later uninstalled, the two cable gland halves can be simply unlocked from one another again using a screwdriver.



图 1 – UNI Split Gland<sup>®</sup>  
Fig. 1 – UNI Split Gland<sup>®</sup>

图 2 – UNI Split Gland<sup>®</sup> — 背面 接口螺纹上有密封件  
Fig. 2 – The back of the UNI Split Gland<sup>®</sup> with a sealing on the connection thread

图 3 – UNI Split Gland<sup>®</sup> 安装在电缆束上  
Fig. 3 – UNI Split Gland<sup>®</sup> installed on a cable bundle

**UNI Split Gland® — 可分体式接头**

UNI Split Gland® – Splittable gland body



图 1  
Fig. 1



图 2  
Fig. 2

可分体式电缆接头  
公制螺纹 EN 60423  
防护等级 IP 67, 类型 4X

Splittable cable gland  
Metric connection thread EN 60423  
Type of protection IP 67, Type 4X

**i** 拧紧力矩的提示信息请参见安装说明书。每个包装单元内均附带安装说明书。  
Advices about tightening torques see assembly instruction. Included in every packaging unit

| 螺纹接头外壳材质<br>Material gland body | 规格/颜色<br>Version/colour | 订购编号<br>Art. no. supplement | 温度范围最小值/最大值<br>Temperature range min./max. |
|---------------------------------|-------------------------|-----------------------------|--|
| PC                              | 灰色<br>grey              |                             | -20 °C / +80 °C                            |
| PC                              | 纯黑色<br>black            | n                           | -20 °C / +80 °C                            |



图 3  
Fig. 3

| 连接螺纹/长度<br>Connection thread/length | 料号<br>Art. no.                 | 压紧螺栓最大开启压力<br>Opening pressure screw max. | 安装高度<br>Mounting height | 扳手开口宽度<br>Spanner width |
|-------------------------------------|--------------------------------|---|-------------------------|-------------------------|
| A                                   | D mm<br>灰色/gey =<br>黑色/blk = n | F mm                                      | C mm                    | SW x E mm               |
| M20x1.5                             | 10.0 CUSG 922053 PC            | 15.0                                      | 29.7                    | 30x33.5 10              |
| M25x1.5                             | 11.0 CUSG 922554 PC            | 20.5                                      | 38.5                    | 35x38.5 10              |
| M32x1.5                             | 14.0 CUSG 923255 PC            | 26.9                                      | 39.6                    | 46x51.3 10              |

延伸产品说明详情指示  
Indicate product details

**i** UL 认证仅针对结合使用 TPE-V 材质的内塞  
UL certification only in combination with sealing inserts made of TPE-V

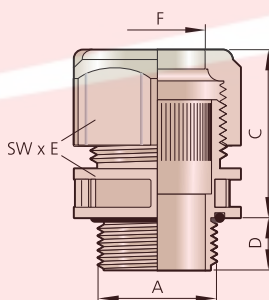
**i** 相应的带开缝密封嵌件参见页码起自 96  
Corresponding slit sealing inserts from page 96

**分体式锁紧螺母**  
Lock nut splittable

RoHS



图 1  
Fig. 1

尼龙  
公制螺纹符合 EN 60423  
温度范围: -40 °C 至 +100 °C  
Polyamide  
Metric thread as per EN 60423  
Temperature range: -40 °C up to +100 °C

**i** 用可调扳手进行安装。

| 螺纹接头外壳材质<br>Material gland body | 规格/颜色<br>Version/colour | 订购编号<br>Art. no. supplement | 温度范围最小值/最大值<br>Temperature range min./max. |
|---------------------------------|-------------------------|-----------------------------|--|
| PA 66-6                         | 灰色<br>grey              | u                           | -40 °C / +100 °C                           |
| PA 66-6                         | 纯黑色<br>black            | n                           | -40 °C / +100 °C                           |



图 2  
Fig. 2

| 连接螺纹<br>Connection thread | 料号<br>Art. no.           | 安装高度<br>Mounting height | 扳手开口宽度<br>Spanner width |
|---------------------------|--------------------------|-------------------------|-------------------------|
| A                         | 灰色/gey = u<br>黑色/blk = n | C mm                    | SW x E mm               |
| M20x1.5                   | 91420/220C               | GGM 8.0                 | 27x30 10                |
| M25x1.5                   | 91420/225C               | GGM 9.0                 | 32x35 10                |
| M32x1.5                   | 91420/232C               | GGM 12.0                | 40x45 10                |

延伸产品说明详情指示  
Indicate product details

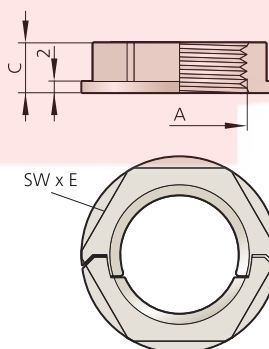

UNI Split Gland® HD – 可分体式接头

UNI Split Gland® HD – Splittable gland body



图 1  
Fig. 1

图 2  
Fig. 2

可分体式电缆接头  
公制螺纹 EN 60423  
防护等级 IP 67, 类型 4

Splittable cable gland  
Metric connection thread EN 60423  
Type of protection IP 67, Type 4

**i** 拧紧力矩的提示信息请参见安装说明书。每个包装单元内均附带安装说明书。  
Advices about tightening torques see assembly instruction. Included in every packaging unit

|                                 |                         |  |
|---------------------------------|-------------------------|--|
| 螺纹接头外壳材质<br>Material gland body | 规格/颜色<br>Version/colour | 温度范围最小值/最大值<br>Temperature range min./max. |
| 锌压铸件<br>Zinc die casting        | 镀锌<br>zinc plated       | -20 °C / +80 °C                            |



图 3  
Fig. 3

|                                     |                |                         |                         |
|-------------------------------------|----------------|-------------------------|-------------------------|
| 连接螺纹/长度<br>Connection thread/length | 料号<br>Art. no. | 安装高度<br>Mounting height | 扳手开口宽度<br>Spanner width |
| A                                   | D              | C                       | SW x E                  |
| M25x1.5                             | 11.0           | 20.6                    | 36x40                   |
|                                     | CUSG 922554 Zn | 36.5                    | 10                      |

**i** UL 认证仅针对结合使用 TPE-V 材质的内塞  
UL certification only in combination with sealing inserts made of TPE-V

**i** UNI Flange® HD/UNI Split Gland® HD: 作为标准内塞仅使用 T80s 材质的带开缝内塞 (参见页码 99)。  
UNI Flange® HD/UNI Split Gland® HD: As sealing insert standard only use the slit sealing inserts made of T80s (see page 99).

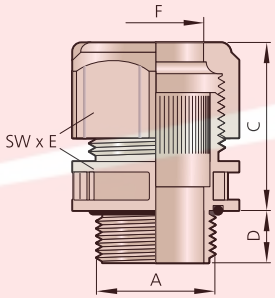
**i** M25 相应的带开缝内塞参见页码起自 96  
Corresponding slit sealing inserts in size M25 from page 96

分体式 HD 锁紧螺母

Lock nut splittable HD

RoHS



图 1  
Fig. 1

锌压铸  
公制螺纹符合 EN 60423  
Zinc die casting  
Metric thread as per EN 60423

|                                 |                         |  |
|---------------------------------|-------------------------|--|
| 螺纹接头外壳材质<br>Material gland body | 规格/颜色<br>Version/colour | 温度范围最小值/最大值<br>Temperature range min./max. |
| 锌压铸件<br>Zinc die casting        | 镀锌<br>zinc plated       | -20 °C / +80 °C                            |



图 2  
Fig. 2

|                           |                |                         |                         |
|---------------------------|----------------|-------------------------|-------------------------|
| 连接螺纹<br>Connection thread | 料号<br>Art. no. | 安装高度<br>Mounting height | 扳手开口宽度<br>Spanner width |
| A                         | C              | mm                      | SW x E                  |
| M25x1.5                   | CGGM 9225 Zn   | 4.5                     | 36x39.5                 |
|                           |                |                         | 10                      |

带开缝的内塞  
*Slit sealing inserts*

5

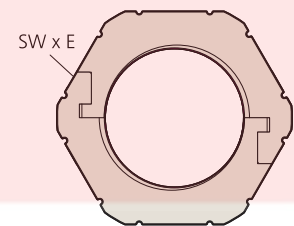
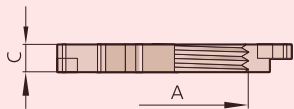

图 1 – UNI Flange® 的各个零件  
*Fig. 1 – Individual components of the UNI Flange®*

图 2 – 使用撑开钳可以更容易地将电缆放到有开缝的多孔内塞中。  
*Fig. 2 – Placing the cable into the slit multiple sealing insert is made easier with the expanding pliers.*

### 从标准型到多孔型

借助带开缝的内塞，预制电缆可以简单安全的穿过。该内塞可以和 UNI FLANSCH、UNI FLANSCH HD 以及分体式电缆接头 UNI Split Gland® 和 UNI Split Gland® HD 一起使用。产品的完全分体式被作为整体方案，开缝内塞是这种使用原理的延伸充。

多孔内塞可以穿过多根预制电缆并节省空间——即使截面各不相同。此外，PFLITSCH 还提供适用于扁平 and 特殊电缆的内塞。有 TPE-V 和 TPE (T80s) 材质的内塞可供使用。

开缝内塞有标准版和多孔版可供使用。此外，还有闭合版内塞。多孔内塞的空置开孔可以用密封螺栓填上。PFLITSCH 提供该部件（参见页码 234）。

此外，PFLITSCH 还提供“按照所需进行开孔”的原则：只要提出所需的孔形，PFLITSCH 就可以在相应的闭合内塞上钻孔。另外使用者可以用专用钻头自己开孔。PFLITSCH 撑开钳作为安装辅助工具，使电缆能够轻松地放入到多孔内塞内（参见页码 244）。

### From standard to multiple

Using slit sealing inserts, assembled cables can be simply and easily fed through enclosure walls. These sealing inserts can be used with the splittable UNI Flange® and UNI Flange® HD cable entry systems and the splittable UNI Split Gland® as well as the UNI Split Gland® HD cable gland. The overall concept for these products based on full splitability. The slit sealing insert is a practical extension of this principle.

Multiple-cable sealing inserts provide a space-saving means of conducting multiple preassembled cables, even if they have different cross sections. PFLITSCH also provides inserts for flat and special cables made of TPE-V and TPE (T80s).

Slit sealing inserts can be used as standard and also as multiple versions. Closed sealing inserts are also available. Unused holes in a multi-cable sealing insert must be sealed with the help of blanks. These may be obtained from PFLITSCH (see page 234).

Furthermore, PFLITSCH offers holes according to the „customised perforations“ principle: simply tell us the details of the holes you want and PFLITSCH will bore them for you in the appropriate solid sealing inserts. Alternatively users can create the holes themselves using special drills. PFLITSCH spreading pliers are used as an installation aid to ease the task of inserting cables into multiple-cable sealing inserts (see page 244).



图 1 – UNI Dicht® – 使用标准开缝  
Fig. 1 – UNI Dicht® insert standard slit

图 2 – UNI Dicht® – 使用多重开缝  
Fig. 2 – UNI Dicht® insert multiple slit

**UNI Dicht® 一 封闭式密封嵌件**

UNI Dicht® sealing insert closed

RoHS



图 1  
Fig. 1

**TPE-V 制密封件  
封闭式**

Sealing insert made of TPE-V  
Closed

材质  
Material

颜色  
Colour

温度范围最小值/最大值  
Temperature range min./max.

TPE-V

原色  
natural

-40 °C / +135 °C

连接螺纹

Connection thread  
A

料号

Art. no.

M20

CUFE 953pg



25

M25

CUFE 954pg

25

M32

CUFE 955pg

25

42601 | TT09950

**UNI Dicht® 一 开缝式标准内塞**

UNI Dicht® sealing insert standard slit

RoHS



图 1  
Fig. 1



图 2  
Fig. 2

**TPE-V 制内塞  
开缝式内塞**

Sealing insert made of TPE-V  
Standard slit

材质  
Material

颜色  
Colour

温度范围最小值/最大值  
Temperature range min./max.

TPE-V

原色  
natural

-40 °C / +135 °C

连接螺纹

Connection thread  
A

料号

Art. no.

线径范围

Sealing range  
最大/最小 ø  
mm

M20

CUFE 953p8

8.0 – 6.0



25

CUFE 953p9

9.5 – 7.0

25

CUFE 953p11

10.5 – 8.0

25

CUFE 953p13

13.0 – 9.5

25

CUFE 953p16

14.5 – 11.5

25

M25

CUFE 954p11

11.0 – 9.0

25

CUFE 954p13

13.0 – 11.0

25

CUFE 954p16

15.0 – 12.0

25

CUFE 954p18

18.0 – 14.0

25

CUFE 954p20

20.0 – 18.0

25

M32

CUFE 955p 8

8.0 – 5.5

25

CUFE 955p13

13.0 – 9.0

25

CUFE 955p16

15.5 – 11.5

25

CUFE 955p18

18.0 – 14.0

25

CUFE 955p20

20.5 – 17.0

25

CUFE 955p25

25.0 – 20.5

25

CUFE 955p28

26.5 – 24.0

25

42603 | TT09940

UNI Dicht® 一开缝式多孔内塞

UNI Dicht® sealing insert multiple slit

RoHS



图 1  
Fig. 1



图 2  
Fig. 2

TPE-V 制内塞  
多孔开缝式

Sealing insert made of TPE-V  
Multiple slit

**i** 根据要求可提供其他型号  
Other versions on request

|                |               |  |
|----------------|---------------|--|
| 材质<br>Material | 颜色<br>Colour  | 温度范围最小值/最大值<br>Temperature range min./max. |
| TPE-V          | 原色<br>natural | -40 °C / +135 °C                           |

| 连接螺纹<br>Connection thread<br>A | 料号<br>Art. no.    |                       |
|--------------------------------|-------------------|-----------------------|
| M20                            | CUFE 953pm1x3/1x9 | 25                    |
|                                | CUFE 953pm2x4     | 25                    |
|                                | CUFE 953pm2x5     | 25                    |
|                                | CUFE 953pm2x5/1x6 | 25                    |
|                                | CUFE 953pm2x6     | 25                    |
|                                | CUFE 953pm3x3     | 25                    |
|                                | CUFE 953pm4x4     | 25                    |
|                                | CUFE 953pm6x4     | 25                    |
|                                | M25               | CUFE 954pm1x3,5/1x7,5 |
| CUFE 954pm1x4/1x5/1x13         |                   | 25                    |
| CUFE 954pm1x4,3/1x6/1x8        |                   | 25                    |
| CUFE 954pm1x4,5/2x7/1x8        |                   | 25                    |
| CUFE 954pm1x4,5/2x8            |                   | 25                    |
| CUFE 954pm1x5/1x9              |                   | 25                    |
| CUFE 954pm1x5,7/1x13           |                   | 25                    |
| CUFE 954pm1x5,7/2x6,3/1x8,5    |                   | 25                    |
| CUFE 954pm1x6/1x8              |                   | 25                    |
| CUFE 954pm1x6/2x9              |                   | 25                    |
| CUFE 954pm1x6,5/1x12           |                   | 25                    |
| CUFE 954pm1x7                  |                   | 25                    |
| CUFE 954pm1x7/1x8/1x8,5        |                   | 25                    |
| CUFE 954pm1x7/1x8,5            |                   | 25                    |
| CUFE 954pm1x7/1x10,5           |                   | 25                    |
| CUFE 954pm1x8,5/1x12           |                   | 25                    |
| CUFE 954pm1x9/1x10             |                   | 25                    |
| CUFE 954pm2x4,5                |                   | 25                    |
| CUFE 954pm2x4,5/1x13           |                   | 25                    |
| CUFE 954pm2x6                  |                   | 25                    |
| CUFE 954pm2x6/2x8              |                   | 25                    |
| CUFE 954pm2x7,2/1x10,5         |                   | 25                    |
| CUFE 954pm2x8                  |                   | 25                    |
| CUFE 954pm2x9                  |                   | 25                    |
| CUFE 954pm3x4                  | 25                |                       |
| CUFE 954pm3x5                  | 25                |                       |



Leuchtturm  
Automation

42600 | IT09950

接下页  
Continued on next page

**UNI Dicht® 一开缝式多孔内塞**  
UNI Dicht® sealing insert multiple slit

◀ 接上页  
Continued from previous page

连接螺纹  
Connection thread  
A

料号  
Art. no.

| 连接螺纹<br>Connection thread<br>A | 料号<br>Art. no.            |    |
|--------------------------------|---------------------------|----|
| M25                            | CUFE 954pm3x6/1x8         | 25 |
|                                | CUFE 954pm3x6/2x8         | 25 |
|                                | CUFE 954pm3x7             | 25 |
|                                | CUFE 954pm3x9             | 25 |
|                                | CUFE 954pm4x5             | 25 |
|                                | CUFE 954pm4x6             | 25 |
|                                | CUFE 954pm4x6/1x8         | 25 |
|                                | CUFE 954pm4x6,5           | 25 |
|                                | CUFE 954pm4x8             | 25 |
|                                | CUFE 954pm5x4             | 25 |
|                                | CUFE 954pm5x5             | 25 |
|                                | CUFE 954pm5x6             | 25 |
|                                | CUFE 954pm6x3             | 25 |
|                                | CUFE 954pm6x4             | 25 |
|                                | CUFE 954pm6x4/1x7         | 25 |
|                                | CUFE 954pm6x5             | 25 |
|                                | CUFE 954pm6x5,5           | 25 |
|                                | CUFE 954pm6x6,5           | 25 |
|                                | CUFE 954pm8x3             | 25 |
|                                | CUFE 954pm8x4             | 25 |
| CUFE 954pm8x5                  | 25                        |    |
| CUFE 954pm8x5,5                | 25                        |    |
| CUFE 954pm9x3                  | 25                        |    |
| M32                            | CUFE 955pm1x6,7/2x10,7    | 25 |
|                                | CUFE 955pm1x7/2x8,5       | 25 |
|                                | CUFE 955pm2x6/1x10,5/1x12 | 25 |
|                                | CUFE 955pm2x6,5/1x10,5    | 25 |
|                                | CUFE 955pm2x10            | 25 |
|                                | CUFE 955pm2x11            | 25 |
|                                | CUFE 955pm3x9             | 25 |
|                                | CUFE 955pm3x11            | 25 |
|                                | CUFE 955pm4x5             | 25 |
|                                | CUFE 955pm4x5/3x7         | 25 |
|                                | CUFE 955pm4x8             | 25 |
|                                | CUFE 955pm4x9             | 25 |
|                                | CUFE 955pm6x6             | 25 |
|                                | CUFE 955pm7x7             | 25 |
| CUFE 955pm8x5,5                | 25                        |    |

**i** 多孔内塞的空置开孔可以用密封螺栓封住。详细信息请参见页码 234。  
Non-assigned holes of multiple sealing inserts can be closed off with sealing plugs. Further information can be found on page 234.

425600 | TT095950

5

Leuchtturm  
Automation

**UNI Dicht® — 内塞 标准开缝 – UNI FLANSCH HD/UNI Split Gland® HD**

UNI Dicht® sealing insert standard slit – UNI Flange® HD/UNI Split Gland® HD

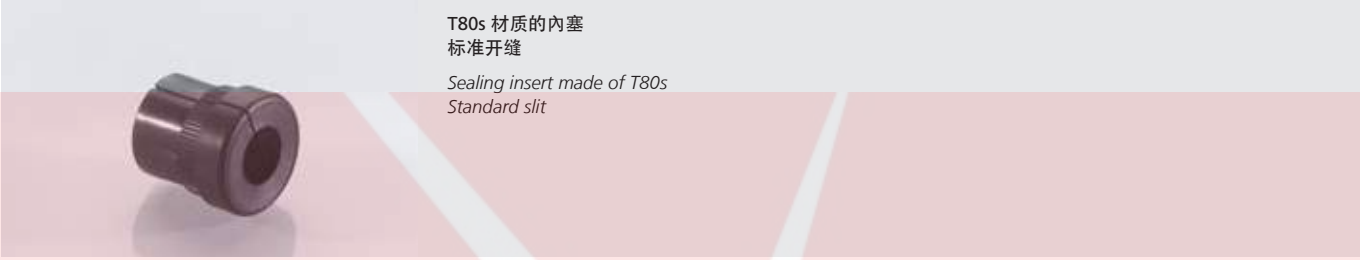

T80s 材质的内塞  
标准开缝

Sealing insert made of T80s  
Standard slit

图 1  
Fig. 1

| 材质<br>Material | 颜色<br>Colour | 温度范围最小值/最大值<br>Temperature range min./max. |
|----------------|--------------|--|
| T80s           | 纯黑色<br>black | -40 °C / +130 °C                           |

| 料号<br>Art. no. | 线径范围<br>Sealing range<br>最大/最小 $\varnothing$<br>mm |  |
|----------------|--|---|
| CUFE 954B11    | 10.5 – 7.0   | 25  |
| CUFE 954B13    | 13.0 – 9.0   | 25  |
| CUFE 954B16    | 15.5 – 11.5  | 25  |
| CUFE 954B18    | 18.0 – 14.0  | 25  |
| CUFE 954B20    | 20.5 – 17.0  | 25  |

47100 | T109910

# Leuchtturm Automation



5

# Leuchtturm Automation

A stylized, light gray silhouette of a lighthouse is centered on the page. The lighthouse has a multi-tiered tower, a lantern room at the top with a glass enclosure, and a small weather vane on top. The background is split vertically into a light pinkish-red left half and a light gray right half. A large, white, starburst-like graphic is overlaid on the lighthouse, with its center at the top of the tower and its arms extending outwards across the page.