

The logo for EPHY MESS, featuring the company name in a bold, sans-serif font. The 'Y' in 'EPHY' is a blue triangle pointing downwards. The background of the logo area shows a close-up of a multi-pin electrical connector with a braided shield.

EPHY MESS

Gesellschaft für Elektro-Physikalische Meßgeräte mbH



Railway Sensors

- Temperature Sensors
- Speed Sensors
- Components for Rail Vehicles

Leuchtturm
Automation

www.ephy-mess.de

深圳市朝瑞自动化系统有限公司



Contents

1.	Requirements of temperature sensors for transportation systems on rail.....	2
2.	Building block system for sensors in the field railway engines	2
2.1	Components of the building block system	3
2.2	Combination of building block elements	4
	Examples of sensor systems	4
	Example of a complex cable system	5
2.3	Function of the building block system	6
3.	Standard temperature sensors	7
4.	Speed sensors	8
5.	Electric data	10
5.1	Electric data of the dc-voltage powered speed sensor	10
5.2	Electric data of the current-loop speed sensor	10
5.3	Electric data of the high voltage 110 V DC speed sensor	11
6.	Electrical protection.....	11
7.	Mechanical parameters.....	11
8.	Cable connection	12
9.	Plug connection	13
10.	Oil level gauges	14
11.	Services	15
	Test adapters	15
	Accessories.....	15

Leuchtturm
Automation



1. Requirements of temperature sensors for transportation systems on rail

Investment and operational costs have to be kept small, thus following requirements are crucial for sensors of public transportation systems:

- simple technical design
- safe operation
- high reliability
- excellent service quality
- fast and safe disconnection from wagon for service works
- low price

To meet the requirements mentioned above, EPHY-MESS GmbH has developed a building block system for sensors in the application field railway engines.

2. Building block system for sensors in the field railway engines

The building block system is based on the principle that the sensors for railway engines are usually broken down into three main assembly groups.



- The sensor itself (temperature, speed etc.). It has to resist extreme vibrations over a long term of time.



- The cable connections, which have to be hard against rock bumps, cleaning fluids, saline solutions etc. in a wide temperature range.



- The plug-in connectors, for them an increased corrosion protection is necessary.



In addition to the assembly groups you will receive installation material which is especially designed for the product and a service packet encircling the product from first design to setting into operation.

The building block system combines tested products. This ensures safe operation, excellent service quality and a high reliability. Expensive, new designs as well as time consuming sample copy releases are not necessary using the building block system. A new sensor is only a modification of a proven sensor system which is already in operation.

The possibility of flexible combination of sensors, cable- and plug connectors allows an individual fit of the measuring system with the requirements in the field of public transportation.

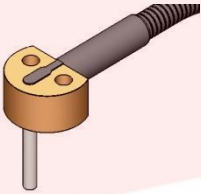
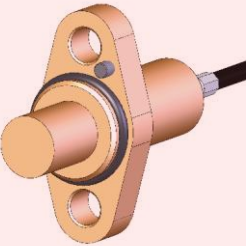
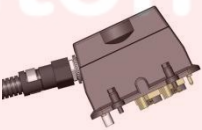

2.1 Components of the building block system

Component	Function	Type
 <p>Temperature sensor (standard)</p>	measuring the temperature	1 x Pt100 (2-, 3-, or 4-wire circuitry) / 2 x Pt100 (2- wire circuitry), massive, highly shockproof type with INOX protection tube Ø5 mm or Ø6 mm. The protection tube length and the size and position of fixing bores are specific to customers' requirements.
 <p>Speed sensor</p>	reliable detection of rotational speed and direction of rotation	Speed sensors, based on incremental impulse sensors, are - beside temperature sensors - part of the modular EPHY-MESS sensor concept. Through the encoder signal the rotating direction and speed of locomotives and multiple units are detected.
 <p>Cable connection</p>	transfer of sensor signals	Halogen- and silicone free shielded wires, optional with additional fabric protection hose, polymere- or metal-corrugated hose with special tightened contact zones.
 <p>Plug connectors</p>	point of intersection of the sensor system to further components	Heavy duty tight plug type, for example Harting, Amphenol, ITT, HTS, adjusted to the specific requirements and transmitted signals.
 <p>Accessories</p>	installation of sensors and wires	Fittings, bolts and installation sors and wires systems, tuned on the sensors, wires and the installation situation at site.
 <p>Service</p>	prevents from annoying detail works	Engineering, ascertain of cable length, prototyping, help on site, preparation of drawings, documentations, installations and proving instructions.



2.2 Combination of building block elements

The components of the building block system can be widely combined to a customized sensor or wiring harness.

Each sensor consists of a measuring receiver, a wiring and if needed a plug connection with tension release.

Examples for sensor systems

one temperature sensor, cable + plug

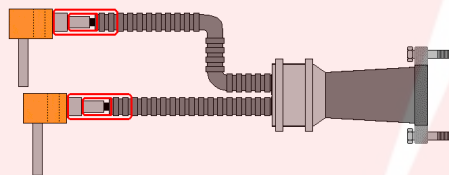
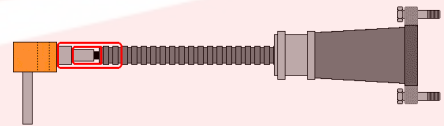

two temperature sensors, cable + plug

one speed sensor, cable + plug

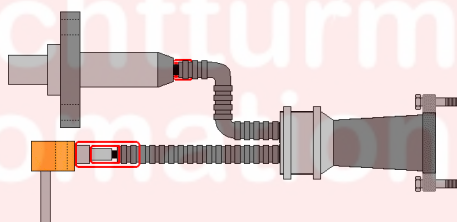
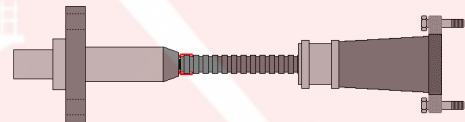

one temperature sensor,
one speed sensor, cable + plug

With one wiring harness up to four sensors can be combined on one main cable which are connected via one plug. A solid integration of components within the wiring harness is also possible, further the use of additional separating plugs which could be necessary for installation and service.

Usually each sensor cable is shielded down to the final plug that minimizes the influence of electrical interference.



Example of a complex cable system:

The wiring harness consists of the following system- and sensor components

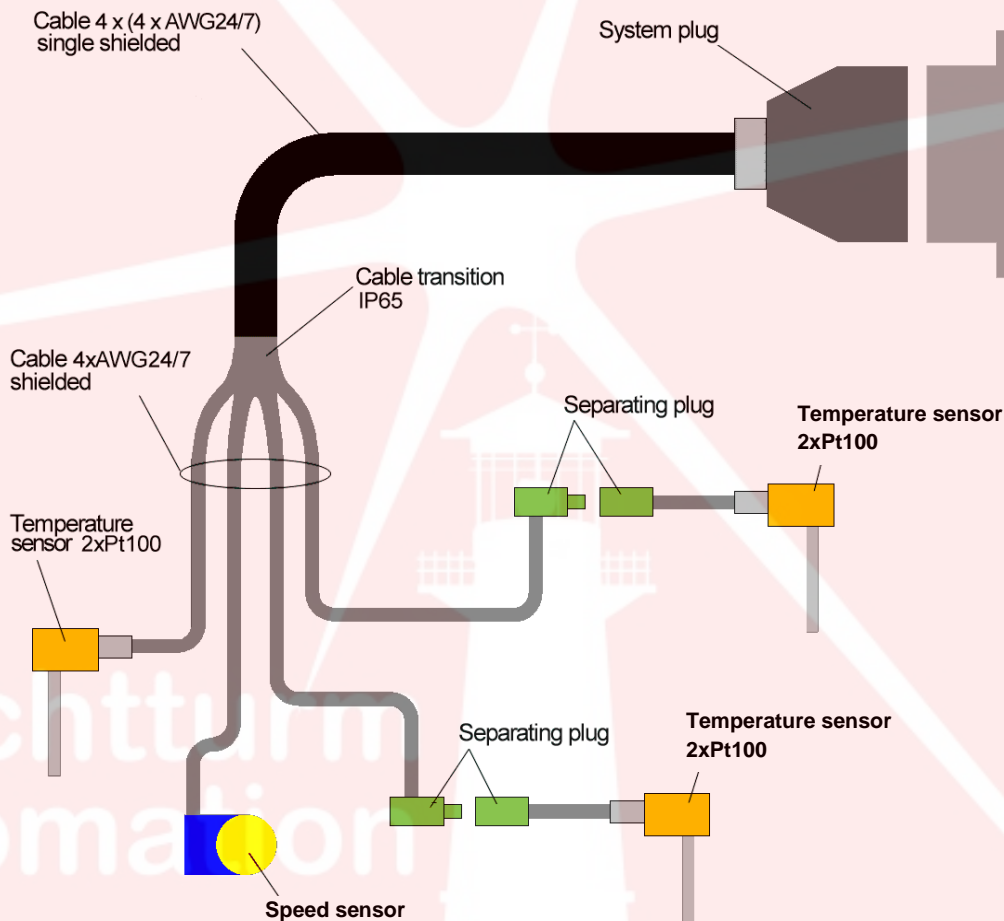

- in addition three double-temperature sensors, two temperature sensors equipped with separating plugs (for cable ducts)
- separating plugs with defined angles installed in two levels
- one speed-sensor, connected steadily
- single cable of sensors using waterproof cable transition (IP65) combined on a system cable
- all sensor cables single shielded (also within the plug and transition)
- unification of all signal wires in one system plug at hand over point
- wiring system has protection class IP65 (waterproof)



2.3 Function of the building block sensor

The concept for a wiring harness of railway engines can be accomplished fast and very easily. You tell us via phone or at your place, type and amount of temperature sensors, preferably the standard type should be used. You choose the type of speed sensor which should be used or you evaluate our suggestions.

We choose, using your requirements and documents, the most practicable wiring harness and work out an offer for your specific project.

1. Choosing the sensors

- 1.1 Investigate amount and type of temperature sensors needed
- 1.2 Layout of temperature sensors geometry
- 1.3 Choose a speed-sensor

2. Layout of structure

- 2.1 Type of wiring (fix / with separating plugs)
- 2.2 Layout of the individual cable lengths
- 2.3 Choice of additional cable protection components (fabric hose, corrugated hose)

3. Layout of plug components

- 3.1 Choice of separating plugs (if necessary)
- 3.2 Choice of system plug (main plug)
- 3.3 Layout of pin selection (plug)

4. Definition of additional attributes

- 4.1 IP-protection type of individual components
- 4.2 Placement of individual components (for example angle-plug)
- 4.3 Type and imposition of electrical shielding

5. Selection of accessories

- 5.1 Cable clamps
- 5.2 Bolts

6. Definition of services

- 6.1 Drawing(s) on paper / data carrier / e-mail
- 6.2 Prototype installation at locality
- 6.3 Installation, proving advices, test adapters
- 6.4 Instruction of your installation personnel at locality
- 6.5 Testimony / certificate acc. DIN EN 10204



3. Standard temperature sensors

Structure of highly shockproof temperature sensors for railway engines

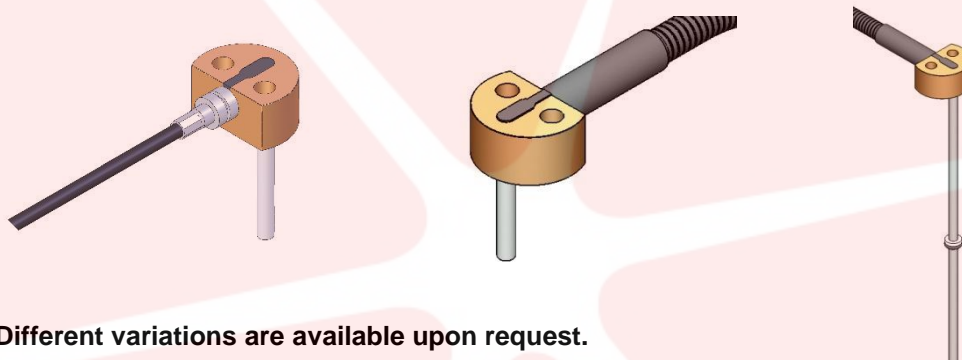

Different variations are available upon request.

The temperature sensor introduced here, is a type **BM-S-Pt100** standard sensor for railway engines.

Connection head: Brass, $\varnothing 32$ mm x 16 mm, casted

Protection tube: INOX, $\varnothing 5.0$ mm, alternative $\varnothing 6.0$ mm

Tension relief: INOX

Measuring element: 1 x Pt100 Class B using 2-, 3- or 4-wire circuitry
2 x Pt100 Class B using 2-wire circuitry

Installation: two fixing bores

Cable: fix connected, placed into a wiring harness, with plug connector or free wire ends

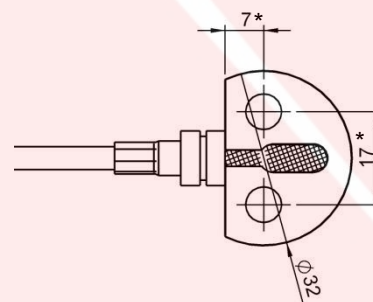
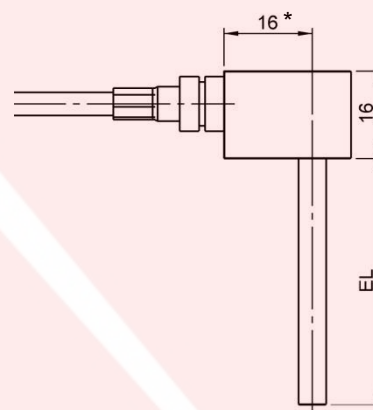

In order to assure the type of sensor head, the following information is necessary:

(standard values are printed in italics)

Connection head The values marked with a * may be varied. Please note values, which differ from standard clearly.

Sensor element 1 x Pt100 2-wire 3-wire 4-wire
 2 x Pt100, 2-wire

Protection tube \varnothing_A 5.0 mm \varnothing_A 6.0 mm others: \varnothing ____ mm
EL (insert length) ____ mm

Fixing bores $\varnothing 8.0$ mm $\varnothing 7.0$ mm $\varnothing 6.5$ mm $\varnothing 5.0$ mm



4. Speed sensors

Speed sensors, based on incremental impulse sensors, are - beside temperature sensors - part of the modular EPHY-MESS sensor concept. Through the encoder signal the rotating direction and speed of locomotives and multiple units are detected. EPHY-MESS speed sensors are used in metros, suburban trains, trams and high-speed trains worldwide. In addition they are applied successfully in the mining industry with its rough conditions.

Features:



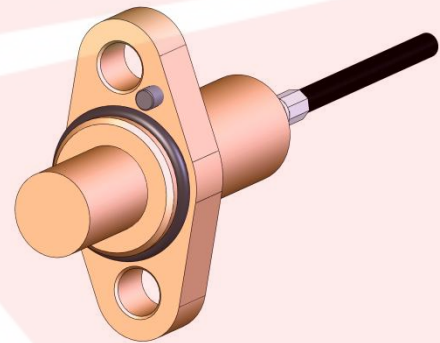

- reliable detection of rotational speed and direction of rotation
- easy and fast installation due to its brass flange housing
- resistant to shocks and vibrations acc. to DIN 61373 Cat. 3
- maintenance- and wear-free
- temperature range up to 125°C
- compact construction
- housing made of brass

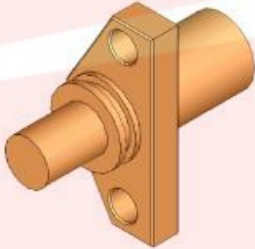

Standard type of the series DWG EM

	<p>DWG 04 Straight cable output</p>
	<p>DWG 05 Cable output aside</p>
	<p>DWG 06 Half flange housing, cable output 180°</p>

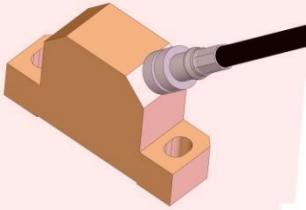

	<p>DWG 07 Threaded sleeve M20x1,5 straight cable output</p>
	<p>DWG 08 Flange housing with asymmetrical flange</p>
	<p>DWG 09 Big flange version, straight cable output</p>
	<p>DWG 21 Flat housing, aside cable output</p>
	<p>DWG 22 Flat housing, backside cable output</p>

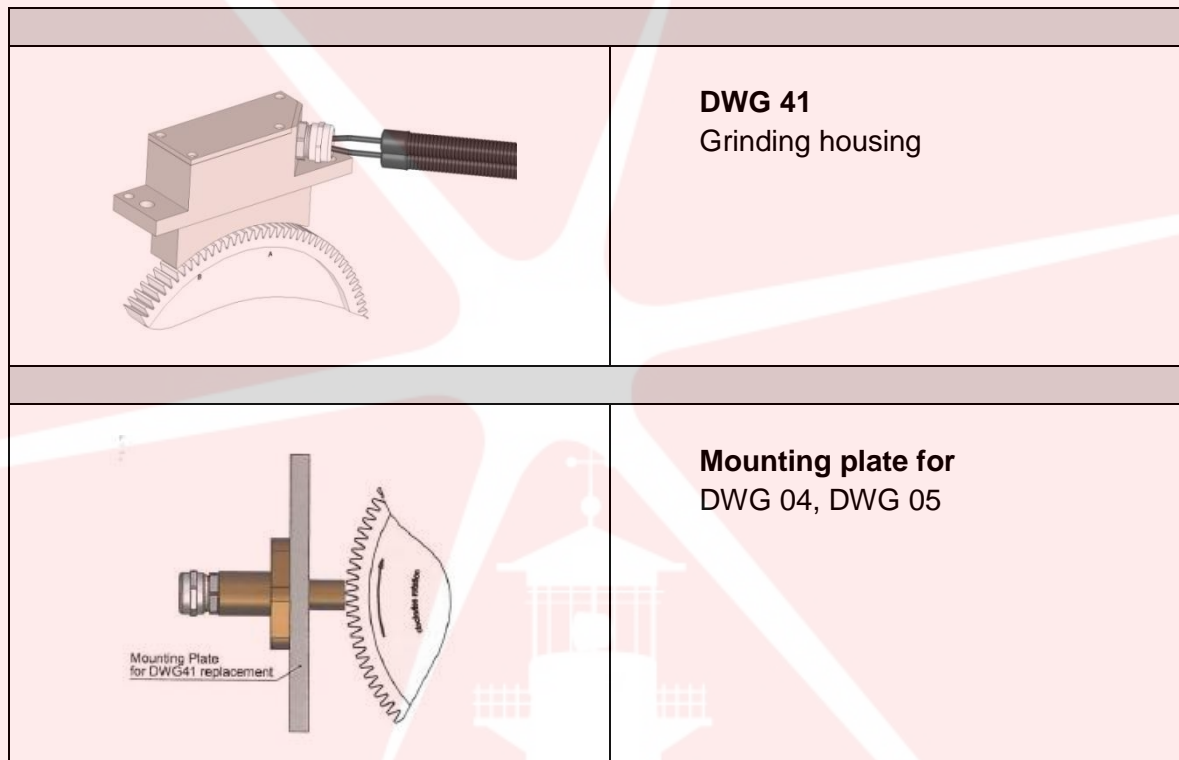

5. Electric data

5.1 Electric data of the dc-voltage powered speed sensor

Supply voltage U_B	8 to 24 V DC (max. 30 V DC)
Current demand without load	< 25 mA at 24 V DC
Insulation resistance	>200 M Ω / 500 V DC <small>encoder-electronics to encoder-housing</small>
Max. output current	20 mA
Frequency range	0.01 – 20000 Hz (standard)
Output level	
high-level	$\geq U_B - 2.0$ V (at 1.67 k Ω load resistance)
low-level	$\leq +1,5$ V
Duty cycle	0.5 \pm 0.2 at involute tothing
Reverse polarity protection	yes, for power supply
Short circuit proof	yes, outputs continuously

5.2 Electric data of the current-loop speed sensor

Supply voltage U_B	max. 24 V DC
Insulation resistance	>200 M Ω / 500 V DC <small>encoder-electronics to encoder-housing</small>
Output current	
low-level	7 mA (5.6 – 8.4 mA)
high-level	14 mA (11.2 – 16.8 mA)
Frequency range	0.01 – 20000 Hz (standard)
Duty cycle	0.5 \pm 0.2 at involute tothing
Reverse polarity protection	yes



5.3 Electric data of the high voltage 110 V DC speed sensor

<i>Supply voltage U_B</i>	110 V DC (77.5 – 137 V DC)
<i>Current demand without load</i>	< 80 mA at 110 V DC
<i>Insulation resistance</i>	>200 M Ω / 500 V DC encoder-electronics to encoder-housing
<i>Max. output current</i>	1 mA
<i>Frequency range</i>	0.01 – 20000 Hz (standard)
<i>Output</i>	both outputs galvanically isolated from each other and from power supply
<i>Output level</i>	
<i>direction left</i>	~ +2.0 V ground-referenced
<i>direction right</i>	~ -2.0 V ground-referenced
<i>Duty cycle</i>	25 μ sec
<i>Reverse polarity protection</i>	yes
<i>Short circuit proof</i>	yes, unlimited

Alternatively available with the electrical data of the version with 24 V.

6. Electrical protection

<i>Shielding</i>	connected to sensor housing
<i>ESD-protection</i>	fulfills requirements acc. EN60947-5-2
	6 kV contact discharge
	8 kV air discharge
<i>Electromagnetic Compatibility (EMV)</i>	track vehicles EN 50121-3-2
<i>Vibration resistance</i>	according EN61373, category 3
<i>Frequency range</i>	200 ... 2000 Hz; 0.5 Oct./min , stimulation: 40 g, number of axes: 3, duration of test: 20 min per axis
<i>Shock resistance</i>	according EN61373, category 3, EN 60068-2-27
<i>Protection (DIN EN 60529)</i>	IP68 (at 8 bar 60 minutes)
<i>Measuring range</i>	-40°C...+125°C
<i>Ambient temperature</i>	-40°C...+125°C
<i>Fire protection</i>	EN45545-2

7. Mechanical parameters

<i>Material of housing</i>	brass (Ms), stainless steel (VA) 1.4571 on demand welding housing (DWG 41) only in aluminum with brass sensor head see drawing picture 1 - 9
<i>Dimensions</i>	M16x1.5*
<i>+Connection</i>	flat housing DW G04 also with M20x1,5**)

* to connect a corrugated pipe, a rubber-textile hose and so on

** not possible for flat housing DWG 21/22.



8. Cable connection

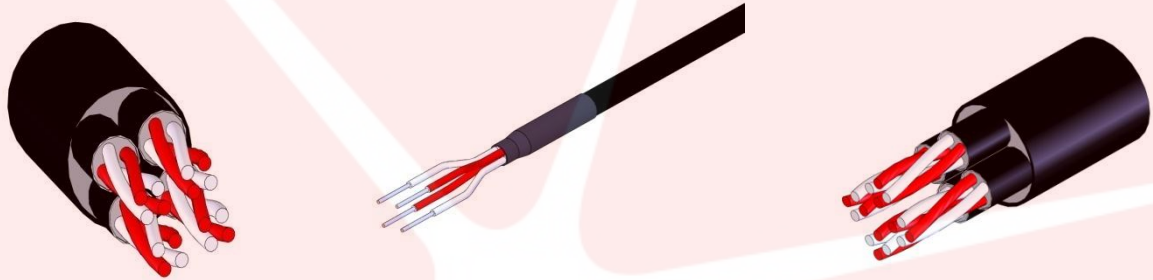

The cable connection is a crucial connecting link between sensors and the plug connectors. The cable depending on utilization in the open air may meet extreme conditions. The EPHY-MESS GmbH therefore utilizes a shielded, special heavy duty hose cable. This cable totally meets all requirements which are asked for in the field of railway focusing on mechanical, chemical and thermal stability.

For applications where a supplementary mechanical protection is necessary the cable or parts of it can be equipped with an additional polymer-, corrugated metal- or rubber fabric enforced hose.

A combination of these elements with the sensors, the down mentioned plug and screwing elements result in - by using the manufacturing and connecting techniques which are harmonized with each other - a sensor (wiring harness) which fulfills all requirements from chapter 1.0, page 2.

Cable 4xAWG 24/7, shielded
4x(4xAWG 24/7), shielded

mechanical protection polymere corrugated hose
metal corrugated hose
rubber fabric enforced hose

Corrugated hose (example)

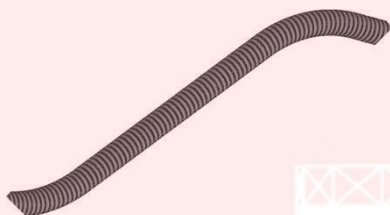

additional rubber fabric enforced hose (example)





9. Plug connections

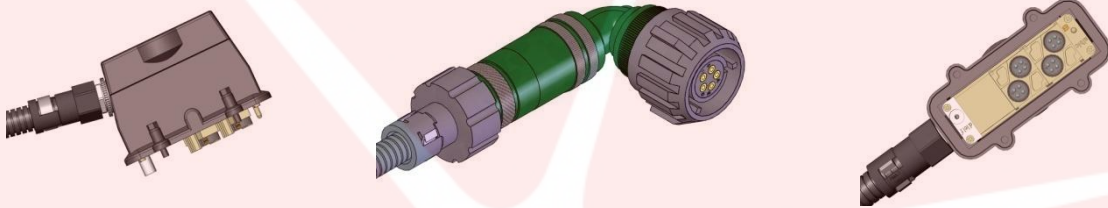

Plug connection(s) at a sensor unit or in a wiring harness enable a non problematic, simple connection of sensors to the evaluation unit. Short cable lengths with a direct cable placing are possible using separating plugs¹⁾ for example. Alternatively by using system plugs the amount of plug components and parts in the system reduces, because the wires are guided focused, which has a positive influence especially on the installation and service.

The plugs have to resist easily the rough environmental influences as well as the sensors and cables.

EPHY-MESS GmbH therefore utilizes well proven, extremely rigid types of plugs which are suitable for this application and ensure the quality of the measuring signal.

Already integrated in the concept of building blocks are plugs (and female connectors) from Harting, Amphenol, ITT, Framatome and HTS.

If your application requires a certain type of plug this unit can usually be integrated in the EPHY-MESS building block concept without any problems.

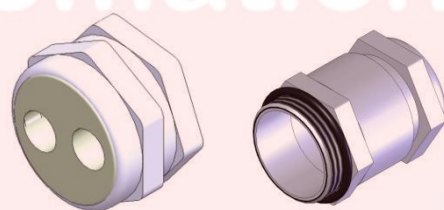
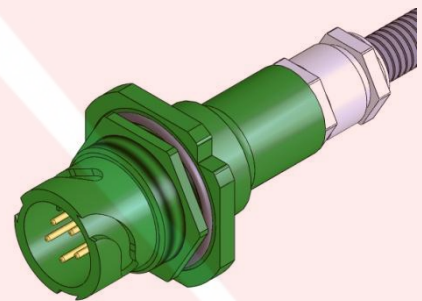

Cable ducts and cable screwing form a system unit with the plug connectors and the connected cable.

All components are tuned on each other. The result is a long-term safe operation. Profit by our experience which we collected from numerous projects in this application field.

¹⁾ **separating plugs:**

Plugs (or female plugs), usually manufactured as built-in plugs to lead the sensor wires through sheets or housings.

²⁾ **system plugs:**

Plugs (or female plugs), where signal wires from many sensors are led to one plug housing.

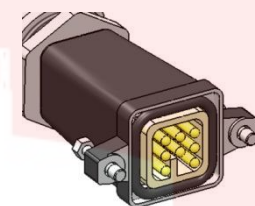



10. Oil level gauges

In the underfloor zone of rail vehicles mechanical strains (rock fall) are a high danger for there located pieces. Highly endangered components are oil level gauges that are used for monitoring the oil level in traction gears. These have to be easily accessible, quick to clean and nevertheless must be extremely impact resistant.

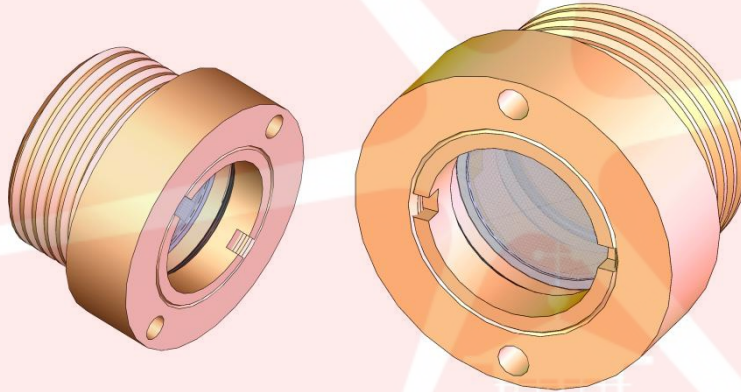

The patented two-chamber system of EPHY-MESS oil level gauges enables a quick control of the oil level and withstands "projectiles" up to a mass of 30g and speed of 50m/s. In case of damage of the sight glass due to a stronger collision, the gear oil won't leak out thanks to the two-chamber system with its integrated protective grid. The destroyed glass can be replaced quickly during a routine test without opening the oil container and emptying the oil. In addition EPHY-MESS oil level gauges are used in very rough and industrial environments like the mining industry.

Features:

- complete retention of the system-tightness also at damage of the outer chamber
- highly resistant against collision
- two-chamber system with integrated protective grid
- repair in case of damage is possible, quick and without opening the oil container
- brass housing

Standard construction:

type:	model:
OSA-03	oil level gauge, brass housing, thread: G2"
OSA-04	oil level gauge, brass housing, thread: G1 ¼"
OSA-05	oil level gauge, brass housing, thread: M48x1,5
OSA-06	oil level gauge, brass housing, thread: G1 1/2"
OSA-xx	oil level gauge according to customers requirements

Special designs on request:

- stainless steel housing

Application:

- oil level control in rail vehicles
- supervision of gears



11. Services

Development - Engineering - Manufacturing - Installation - Documentation

The building block system for sensors in the field of railway engines of the EPHY-MESS GmbH provides more than only a selection of proven and high quality sensor components with equipment for the public transportation techniques. A main component of the system is the service which covers the whole path of the project. By handing over the sensor project engineering to EPHY-MESS you will get free time to solve other problems, in addition you can be sure having a competent and reliable partner for a wide range of sensors.

Documentations

Parallel to the development of your plant we work out a concept for sensors according to your requirements (drawings) by strictly using the elements that meet your demands.

Documentations (technical data, installation instruction, drawings) you will receive upon request in printed matter, on data carrier or via e-mail.

An adaption of the sensors at the installation place by our service team is possible as well as the prototype installation and the instruction of your personnel.

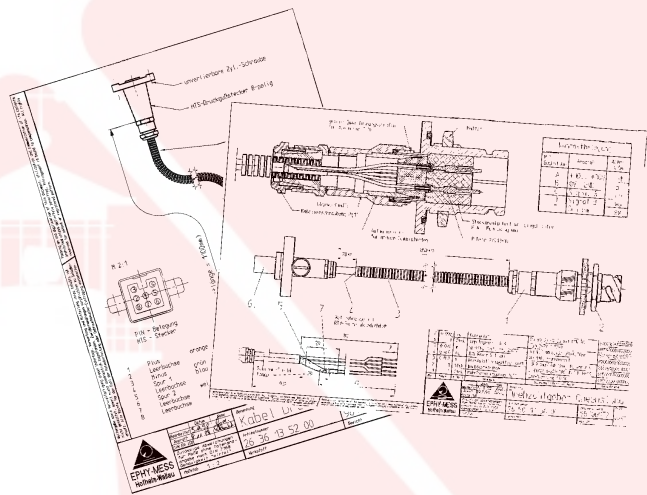

Test adapters

A further line in the spectrum of our services is the manufacturing of test adapters. A test adapter consists of a counterpart of the system plug with the appropriate equipment in order to test the single sensors / circuits during service fast and easily. Further we supply you with test instructions or plans for our sensors, wiring harnesses and test adapters.

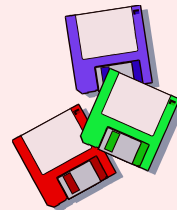

Accessories

In order to make the installation simple, fast and cheap, our railway engine products will be delivered on order with installation accessories (nuts and bolts and fixing material). We use an assortment of fixing materials and accessories which merges to our building block system smoothly. This leads to an easy, safe and fast installation.

Leuchtturm Automation

EPHY MESS

Gesellschaft für Elektro-Physikalische Meßgeräte mbH



Berta-Cramer-Ring 1
D-65205 Wiesbaden
Tel.: 06122 / 9228-0
Fax: 06122 / 9228-99
www.ephy-mess.de

深圳市朝瑞自动化系统有限公司